

CM-CSCD

**SABRENT**  
Connecting Differently™

# UNIVERSAL SMARTPHONE CD SLOT MOUNT

## User Manual



SMARTPHONES

Images for understanding the actual product may differ from products in the box.  
Mobile phone and GPS device are not included.

## Size

55mm - 85mm  
Device Height

6mm - 12mm  
Device Thickness

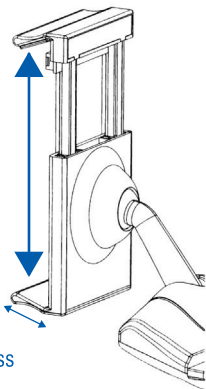

## Component

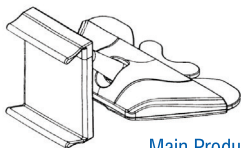

Main Product



Manual

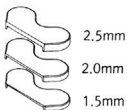

Sub Pad

## Feature

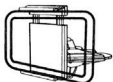

Easy Mount with  
Spring Holder



No tools necessary  
for installation



CD slot mount



3.5"- 5.5"  
smartphone

## Adjustment

Height adjustment  
for easy use



360° Rotation

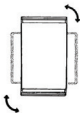

Tilting



## Parts

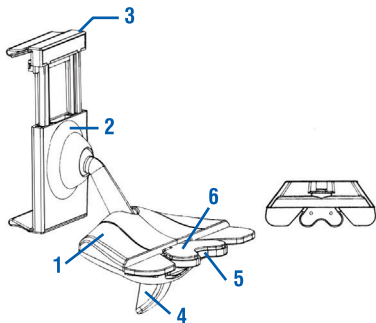

1. Body
2. Holder
3. Spring Holder
4. Locking Lever
5. Locking Wing
6. Sub Pad Hole

## How to use sub pad

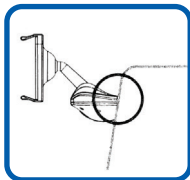

Use Sub Pad when locking wing is loose in the CD slot

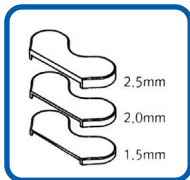

There are three options for sub pad thickness 1.5/2.0/2.5mm

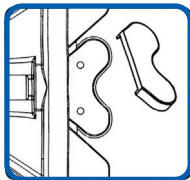

Insert the appropriate sub pad to the sub pad hole on the locking wing

## How to install

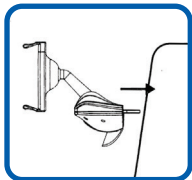

Insert the locking wing of the product into the CD slot



Press the locking lever and fasten the locking wing in the CD slot



## How to mount smartphone

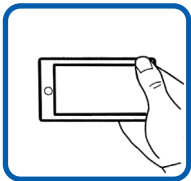

Hold the smartphone with one hand



Push up the spring holder with smartphone

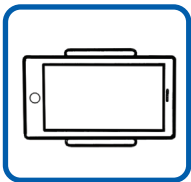

Put the smartphone into the holder and mount it

## Please Note

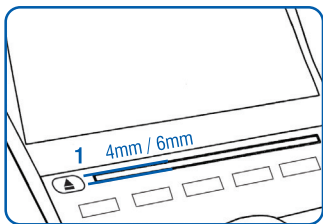

1

Installation accommodates 4mm to 6mm gap  
of CD slot entrance

## Please Note

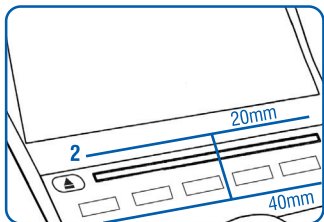

2

20mm upward and 40mm downward from the CD slot is necessary for installation



[sales@sabrent.com](mailto:sales@sabrent.com)

[sabrent.com](http://sabrent.com)